

Abmessungen/dimensions (mm)

Best. Nr. Order no.	DN	ØD1	Ød1	ØD2	Ød2	h	g/Stück g/piece
60223	40 1 ¼"	40,5 ± 0,3	26,2	44,4	32,0 ± 0,3	27,0 ± 0,4	18,0
60224	50 1 ¼"	50,5 ± 0,4	28,0	54,4	32,0 ± 0,3	27,0 ± 0,4	39,0
60225	50 1 ½"	50,5 ± 0,4	36,0	54,4	40,0 ± 0,3	27,0 ± 0,4	27,0

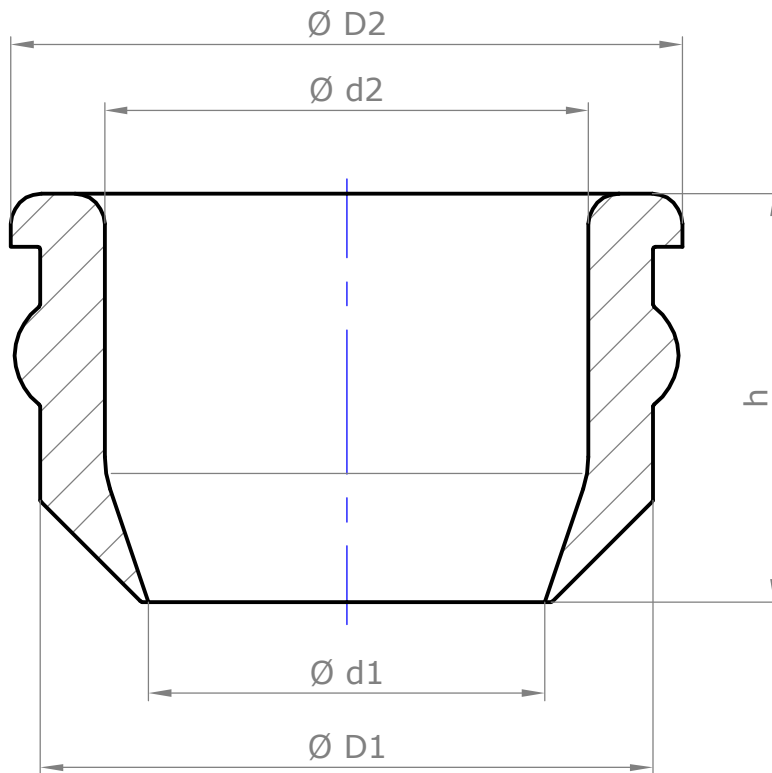

Schutzvermerk ISO 16016 beachten./Refer to protection notice ISO 16016.

2020 Reinking

Wir behalten uns technische Änderungen vor
We reserve technical modifications



M.O.L. Gummiverarbeitung
GmbH & Co. KG
Gutenbergstr. 12-14
49377 Vechta

Sickenwulstnippel
Rubber gasket for socket
DN 40-50 SBR 40 ±5 IRHD